

SPB 12V - 80Ah | VRLA Battery



Applications

- Uninterruptible Power Supplies (UPS)
- Electric Power Systems (EPS)
- Emergency backup power supplies
- Electronic apparatus and equipment
- Communication power supplies
- DC power supplies
- Auto control system

Specifications

Nominal Voltage	12 V	
Number of cells	6	
Design Life	12 years	
Dimensions	Length	350 mm
	Width	167 mm
	Height	179 mm
	Total Height	179 mm
Approx. Weight	24.0 kg	
Nominal Capacity (25°C)	20 hours rate (4.23 A, 10.8 V)	84.6 Ah
	10 hours rate (8.05 A, 10.8 V)	80.5 Ah
	5 hours rate (14.00 A, 10.5 V)	70.0 Ah
	1 hour rate (47.60 A, 10.2 V)	47.6 Ah
Max. Discharge Current (25°C)	800 A (5s)	
Internal Resistance	4.0 mOhms	
Fully Charged battery (25°C)		
Self-Discharge	3% of capacity declined per month at 25°C (average)	
Operating Temperature Range	Discharge	-15°C~50°C
	Charge	-10°C~50°C
	Storage	-20°C~50°C
Short Circuit Current	2600 A	
Charging Characteristics (25°C)	Boost charging voltage	2.40-2.45 Vpc
	Maximum charging current	24.0 A
	Temperature compensation	-30 mV/°C
	Float charging voltage	2.25-2.30 Vpc
	Temperature compensation	-18 mV/°C

Battery Construction

Component	Positive Plate	Negative Plate	Container	Cover	Safety Valve	Terminal	Separator	Electrolyte
Raw material	Lead dioxide	Lead	ABS	ABS	Rubber	Copper	Fiberglass	Sulfuric acid

Dimensions

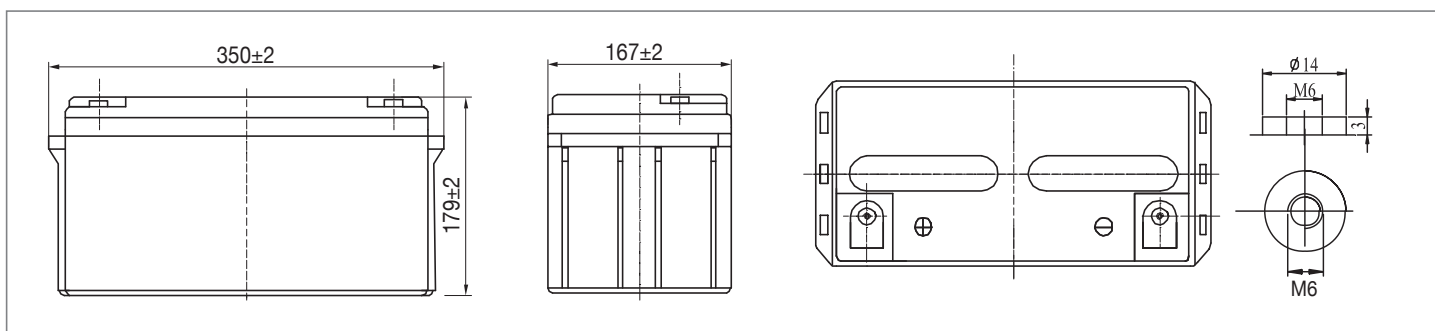

Constant Current Discharge (Amperes) at 25°C

End Voltage (Volts/Cell)	10min	15min	30min	1h	2h	3h	4h	5h	8h	10h	20h
1.60 V	172	135	82.0	49.6	29.2	20.4	16.7	14.3	9.79	8.15	4.29
1.65 V	167	132	80.4	48.9	29.1	20.3	16.6	14.2	9.73	8.14	4.29
1.70 V	160	127	77.9	47.6	28.8	20.1	16.5	14.1	9.67	8.13	4.28
1.75 V	153	123	76.0	46.7	28.4	20.0	16.4	14.0	9.60	8.10	4.25
1.80 V	145	116	73.2	45.2	27.6	19.4	15.9	13.6	9.31	8.05	4.23

Constant Power Discharge (Watts) at 25°C

End Voltage (Volts/Cell)	10min	15min	30min	1h	2h	3h	4h	5h	8h	10h	20h
1.60 V	1860	1486	920	565	339	240	197	169	116	97.2	51.3
1.65 V	1804	1450	902	557	337	238	196	168	116	97.0	51.2
1.70 V	1730	1396	874	543	334	237	194	167	115	96.8	51.1
1.75 V	1655	1349	853	532	329	235	193	165	114	96.2	50.8
1.80 V	1562	1278	822	516	320	228	187	161	111	95.5	50.4

(Note) The above characteristics data are average values obtained within three charge/discharge cycles not the minimum values.

SPB 12V - 80Ah | VRLA Battery

Temperature Effects on Float Life

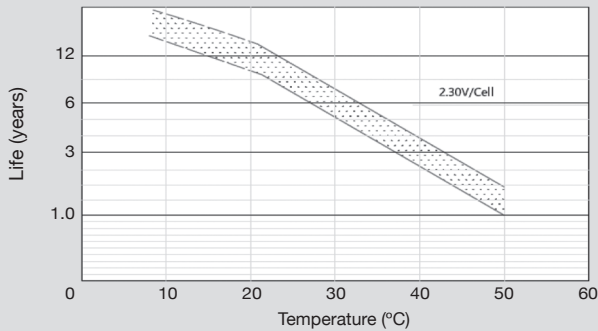

Self Discharge Characteristics

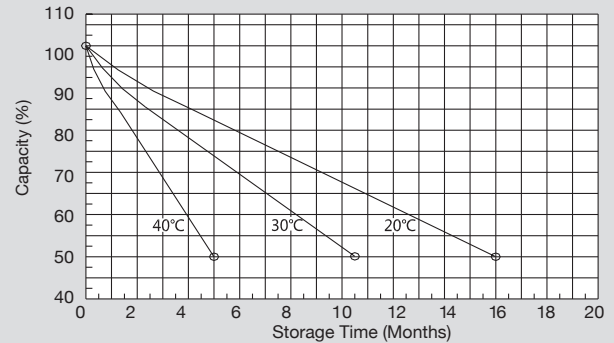

Discharge Characteristics (25°C)

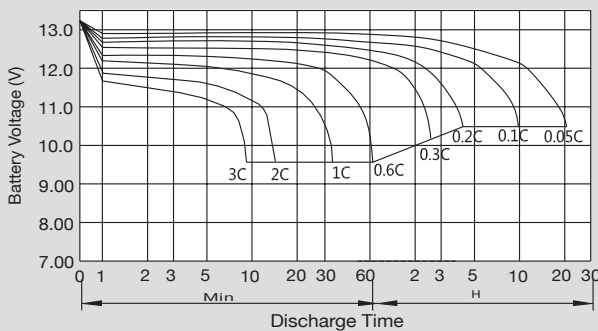

Charging Characteristic (25°C)

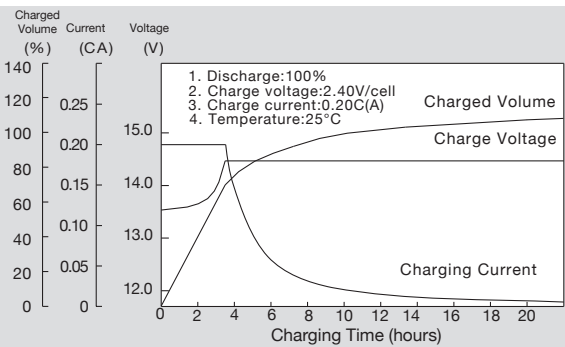

Relationship Between Charging Voltage and Temperature

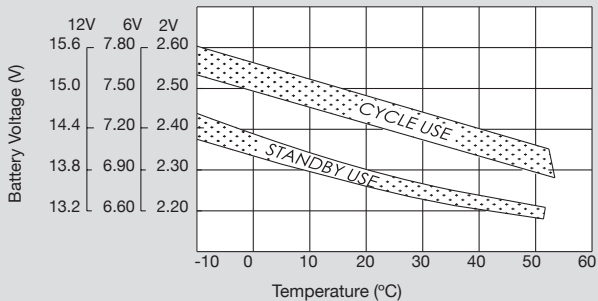

Relationship Between OCV and Residual Capacity (25°C)

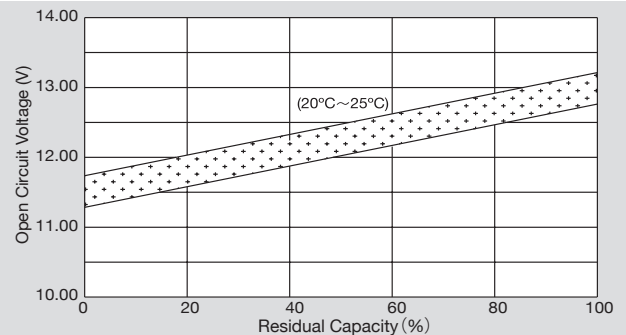

Cycle Service Life in Relation to Depth of Discharge

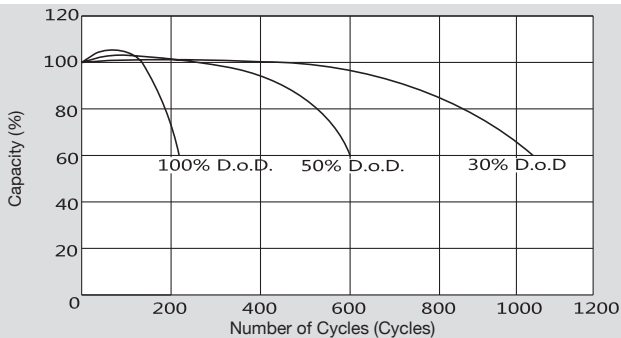

Temperature Effects on Capacity

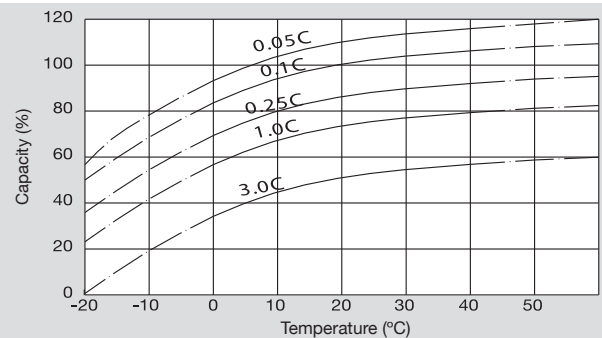

SYSTEMS SUNLIGHT S.A.

Headquarters

2 Ermou & Nikis Str., Syntagma Sq.
105 63 Athens, Attica, Greece

T +30 210 6245400 F +30 210 6245409

European Manufacturing Plant

672 00 Neo Olvio, Xanthi, Greece

T +30 25410 48100 F +30 25410 95446

Global Service Department

366 Tatoiou Str.

136 73 Acharnes, Attica, Greece

T +30 210 6245600 F +30 210 6245619

