

# AccuForce 12V - 75Ah S

## Solar VRLA Battery



### Specifications

Nominal Voltage	12 V	
Number of cells	6	
Cycle Life	Approx. 800 cycles at 50% DOD	
Dimensions	Length	350 mm
	Width	167 mm
	Height	179 mm
	Total Height	179 mm
Approx. Weight	20.4 kg	
Nominal Capacity (25°C)	120 hours rate (0.65 A, 11.1 V)	78.4 Ah
	100 hours rate (0.73 A, 11.1 V)	72.9 Ah
	48 hours rate (1.56 A, 10.8 V)	74.9 Ah
	10 hours rate (6.50 A, 10.8 V)	65.0 Ah
	5 hours rate (11.4 A, 10.5 V)	57.0 Ah
Max. Discharge Current (25°C)	650 A (5s)	
Internal Resistance	6 mOhms	
Fully Charged battery (25°C)		
Self-Discharge	3% of capacity declined per month at 25°C (average)	
Operating Temperature Range	Discharge	-15°C~50°C
	Charge	-10°C~50°C
	Storage	-20°C~50°C
Short Circuit Current	1950 A	
Charging Characteristics (25°C)	Cycle use	2.40-2.48 Vpc
	Maximum charging current	20 A
	Temperature compensation	-30 mV/°C
	Standby use	2.27-2.35 Vpc
Temperature compensation	-18 mV/°C	
Design Floating Life (20°C)	10 years	

### Applications

- Solar / Wind power systems
- Residential installations
- Golf carts and electric powered vehicles
- Marine equipment
- Electric wheelchairs
- Traffic systems (signaling and lighting)
- Remote monitoring and controlling
- Power tools and cleaning machines
- Uninterruptible power supply (UPS)

### Battery Construction

Component	Positive Plate	Negative Plate	Container	Cover	Safety Valve	Terminal	Separator	Electrolyte
Raw material	Lead dioxide	Lead	ABS	ABS	Rubber	Copper	Fiberglass	Sulfuric acid

### Dimensions

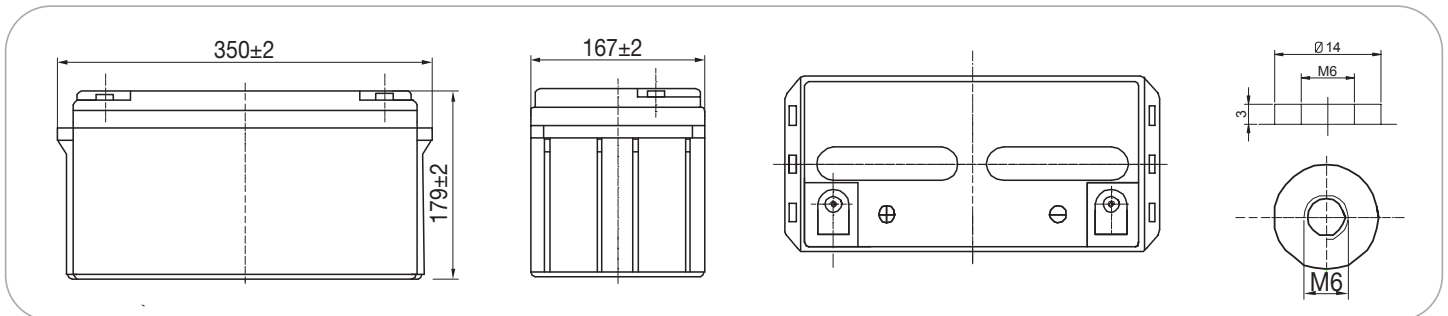

### Constant Current Discharge (Amperes) at 25°C

End Voltage (Volts/Cell)	15min	30min	1h	2h	3h	4h	5h	6h	8h	10h	20h	24h	48h	72h	100h	120h
1.60 V	109	65.7	40.6	23.7	16.6	13.6	11.6	10.1	7.93	6.63	3.47	2.97	----	----	----	----
1.65 V	106	64.4	40.1	23.6	16.5	13.5	11.5	9.95	7.93	6.63	3.46	2.96	----	----	----	----
1.70 V	102	62.4	39.1	23.4	16.4	13.4	11.4	9.95	7.87	6.57	3.46	2.95	1.58	----	----	----
1.75 V	98.2	60.8	38.3	23.1	16.3	13.3	11.4	9.88	7.80	6.57	3.44	2.94	1.57	1.07	----	----
1.80 V	93.0	58.6	37.1	22.5	15.8	12.9	11.1	9.56	7.54	6.50	3.41	2.93	1.56	1.07	----	----
1.85 V	91.2	57.5	34.8	22.6	16.0	12.9	11.3	9.61	7.74	6.45	3.33	2.85	1.52	1.04	0.729	0.653

### Constant Power Discharge (Watts) at 25°C

End Voltage (Volts/Cell)	15min	30min	1h	2h	3h	4h	5h	6h	8h	10h	20h	24h	48h	72h	100h	120h
1.60 V	1190	730	462	273	193	158	137	118	94.3	78.7	41.6	35.8	----	----	----	----
1.65 V	1161	718	456	272	192	157	135	117	94.3	78.7	41.5	35.7	----	----	----	----
1.70 V	1118	697	446	270	191	156	135	117	93.6	78.0	41.5	35.6	19.0	----	----	----
1.75 V	1080	681	437	267	190	155	133	116	93.0	78.0	41.3	35.5	18.9	12.9	----	----
1.80 V	1023	658	424	260	185	152	131	113	89.7	77.4	41.0	35.3	18.8	12.9	----	----
1.85 V	1001	645	397	251	178	148	128	109	87.2	76.2	40.7	34.9	18.5	12.7	8.92	7.98

Note: The above characteristics data can be obtained within three charge/discharge cycles.

# AccuForce 12V - 75Ah S

## Solar VRLA Battery

### Typical Use Life and Operating Temperature

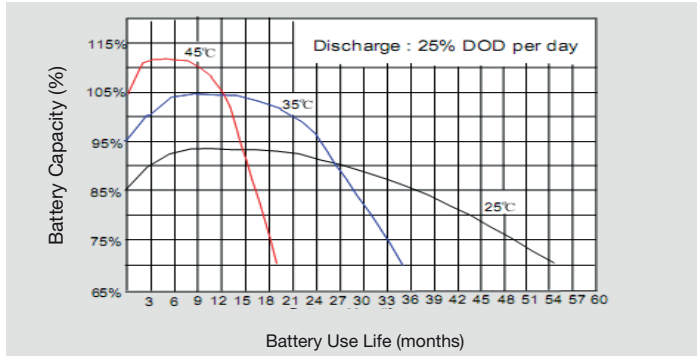

### Self Discharge Characteristics

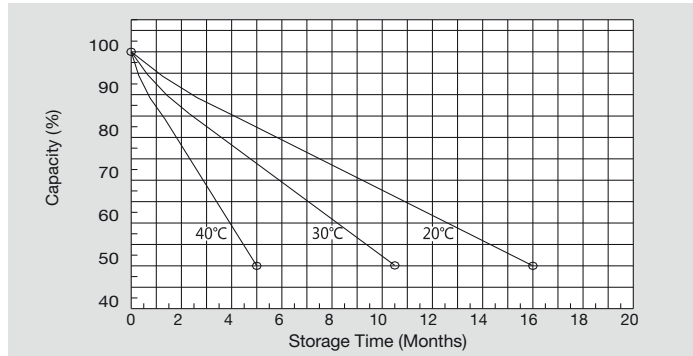

### Discharge Characteristics (25°C)

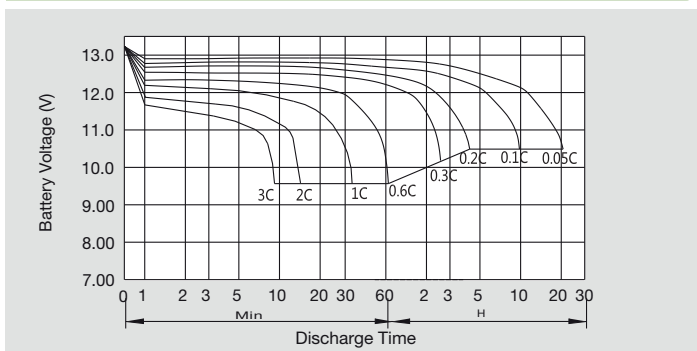

### Charging Characteristics (25°C)

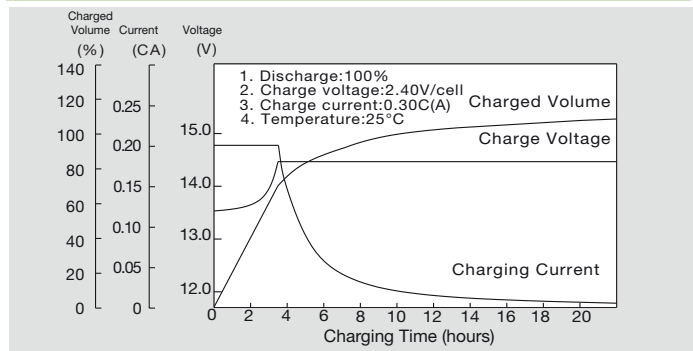

### Relationship Between Charging Voltage and Temperature

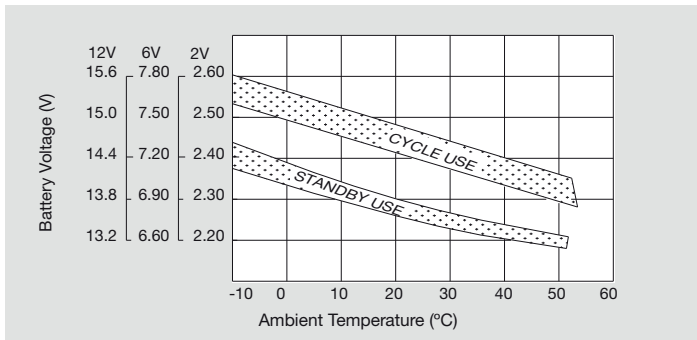

### Relationship Between OCV and Residual Capacity (25°C)

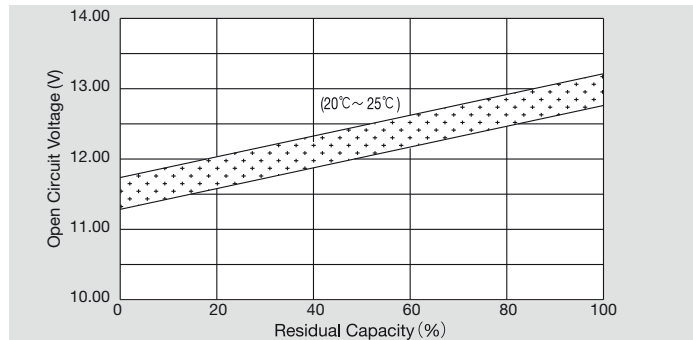

### Cycle Service Life in Relation to Depth of Discharge

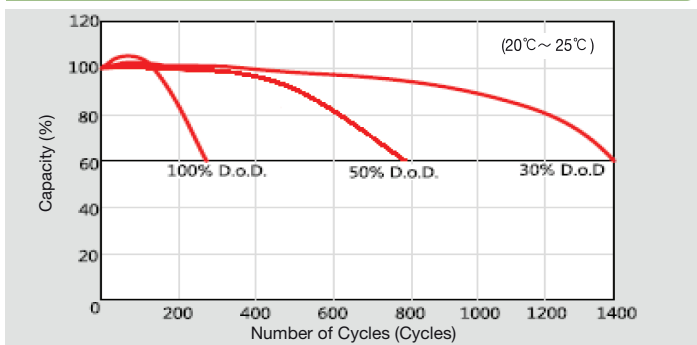

### Temperature Effects on Capacity

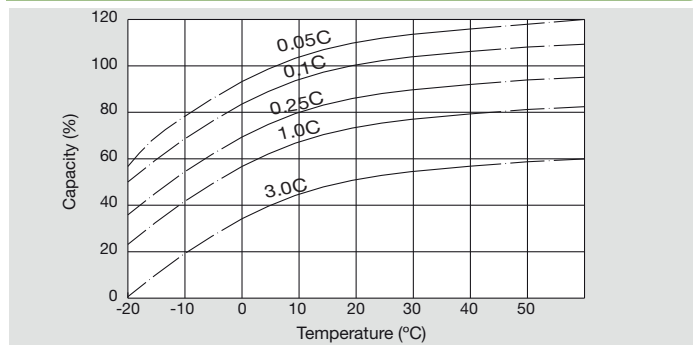

Headquarters 2 Ermou & Nikis Street | Syntagma Square | 105 63 | Athens | Greece | EU

Manufacturing Plant Neo Olvio | 672 00 Xanthi | Greece | EU

Recycling Plant Industrial Area of Komotini | 691 00 Komotini | Greece | EU

Southeast Europe Industrial Sales 14B Menexedon Street | 145 64 Kato Kifissia | Greece | EU

European Battery Assembly (SEBA) 175, Via Stra | 37030 Colognola Ai Colli Verona | Italy | EU

Industrial SRL 11, Soseaua Centurii | 077025 Bragadiru, Judet Ilfov | Romania | EU

T +30 210 6245400

T +30 25410 48100

T +30 25310 82460

T +30 210 6245600

T +39 045 7651771

T +40 021 3517777

F +30 210 6245409

F +30 25410 95446

F +30 25310 82489

F +30 210 6245619

F +39 045 7651771

F +40 021 3516667